

| LEGEND | |
|--------|--------------------------------|
| | - 1/4" QUICK CONNECT |
| | - 1/4" QUICK CONNECT PIGGYBACK |
| | - FORK CONNECTOR |
| | - RING CONNECTOR |
| | - SOCKET CONNECTOR |
| | - PIN CONNECTOR |

33-0010-R5

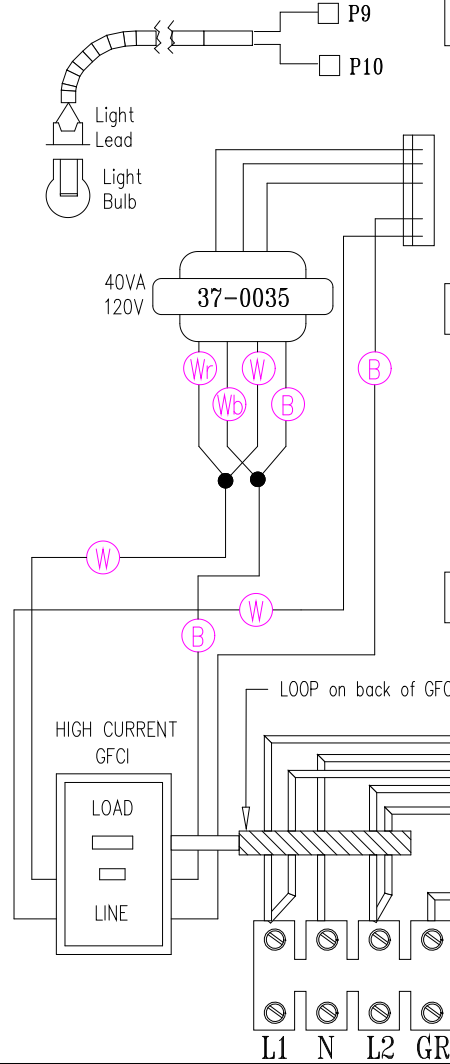
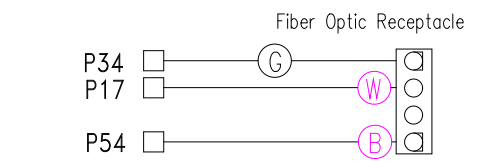
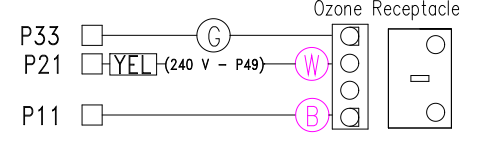
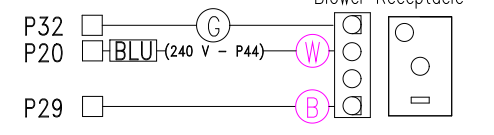
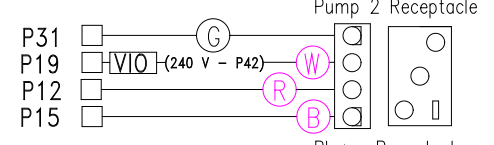
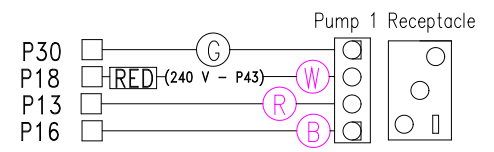
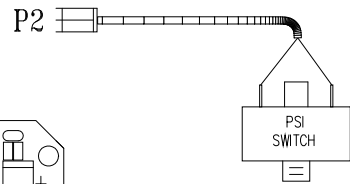
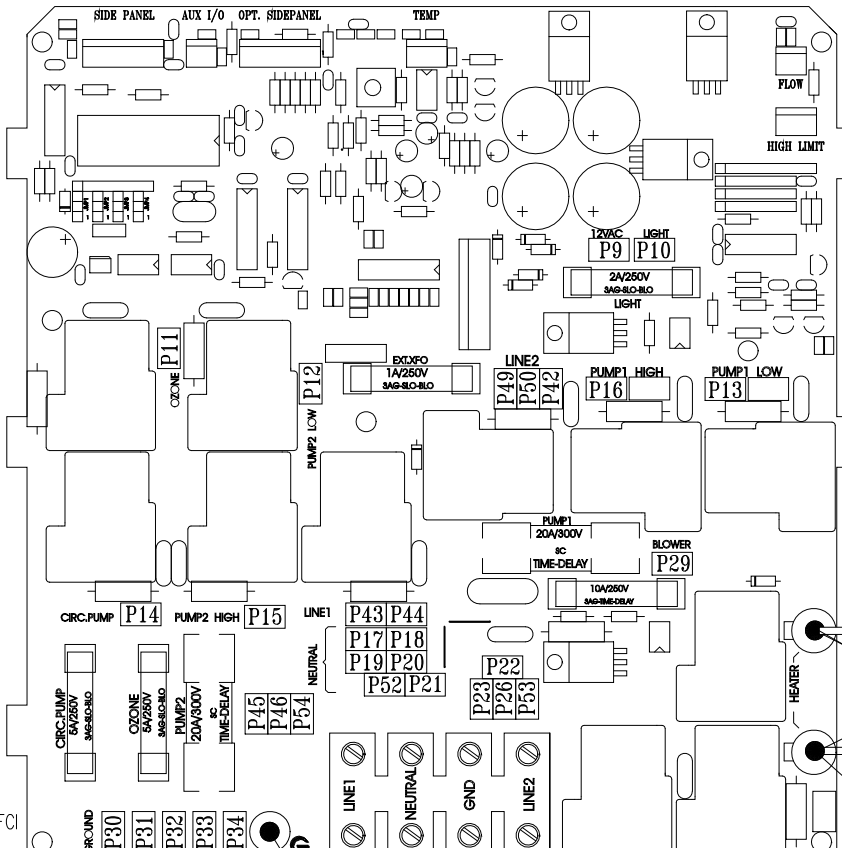

HYDRO-QUIP
CORONA, CA (909) 273-7575

Manufacture Notes:

Approved By:

Dwg. No. **C221AH-HKQY-J**

Drawn **DJT** Rev **7**
Date **6.5.01**

| Wire Color Code | |
|-----------------|------------|
| B - Black | G - Green |
| Br - Brown | Bl - Blue |
| R - Red | V - Violet |
| O - Orange | W - White |
| Y - Yellow | Gr - Gray |

SHADED COMPONENTS ARE 240V

Diagram No. **5000**